

a worksheet

DAVID  
MACKINTOSH

My Dog, Hen, is a picture book whose main theme is sustainability and making the most of something that would ordinarily be discarded.

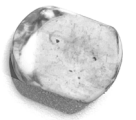

It begins when a dog named Hen is rescued from an animal shelter and carried home in a cardboard box (that was once used for cereal). The family home soon becomes a very creative place with everyone learning new ways to care for their new family member.

Here are some exercises you can do after reading the book. You may be asked to draw, write, paint, design or imagine. Use your creativity and find other uses for the things you have around you.



NB: The pictures in this book were made using oil pencil, ink, watercolour, charcoal, kraft paper and waste paper. I didn't use expensive art materials and I didn't buy anything especially to make the book. Instead, I used what was lying around my studio. I have some paint that is twenty years old and it still works just fine!

Instead of buying a brand new chair, we can re-upholster the one Hen chewed up. Design your own new fabric for the chair. It can be anything you like: colourful, black and white, dotty, pencil-y, painterly, collage-y.

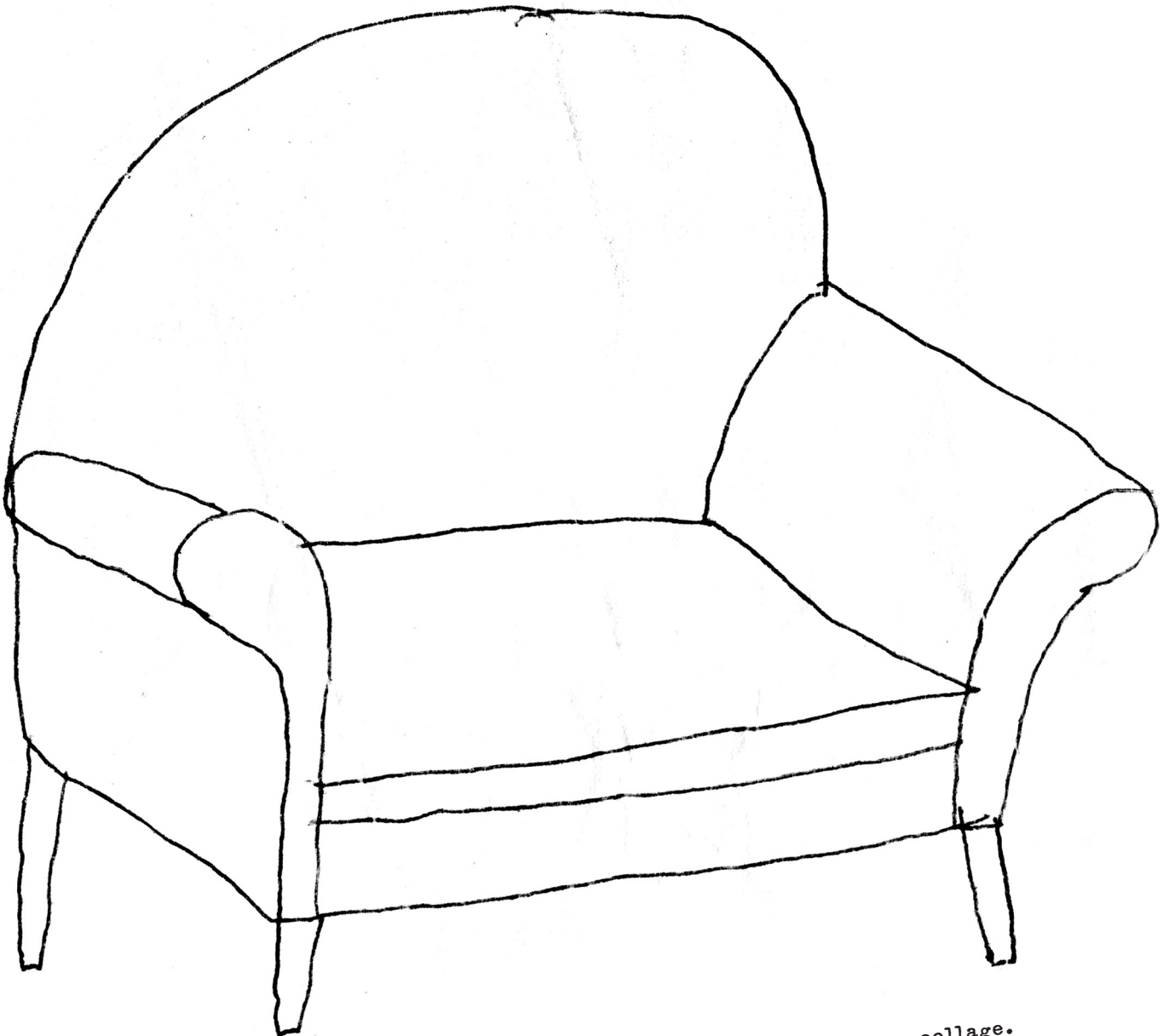

When you're finished, cut out the chair and use in a collage.

**Hen ate his dog-bed and now only sleeps on chairs.**

Draw a dog sleeping on the chairs from when it was a puppy to a fully grown dog. Think about what changes as a puppy becomes older: do legs get longer? do ears stay floppy? Is the head as big compared to the body? See what you can come up with.

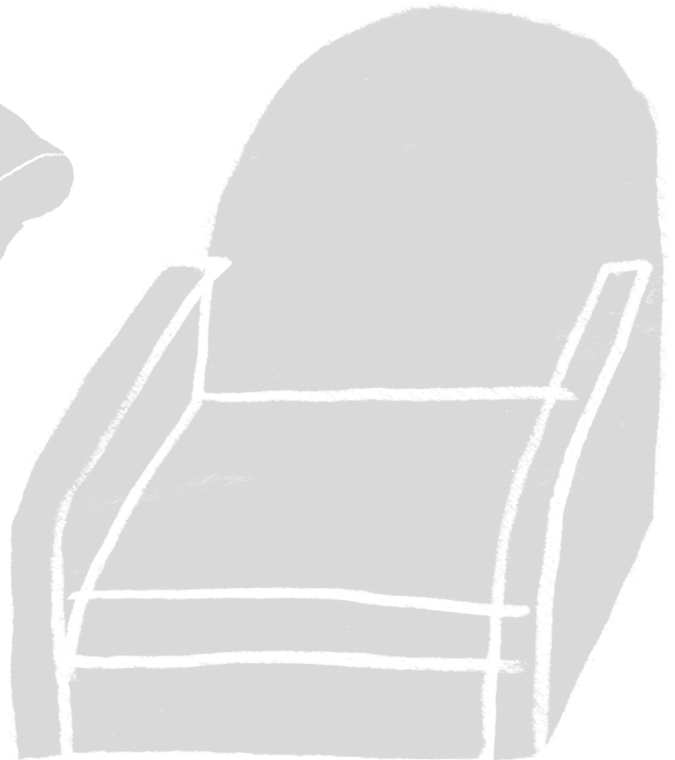
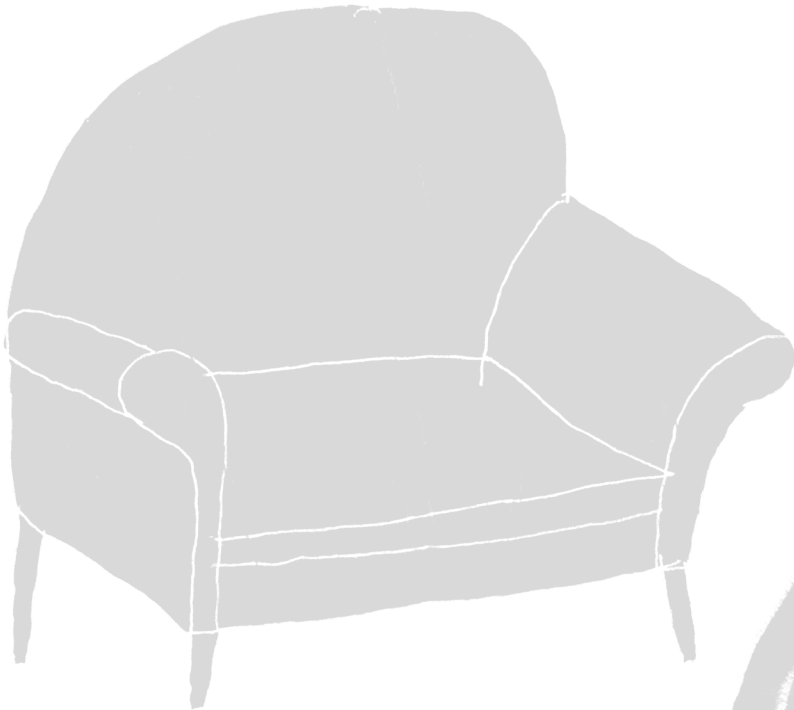
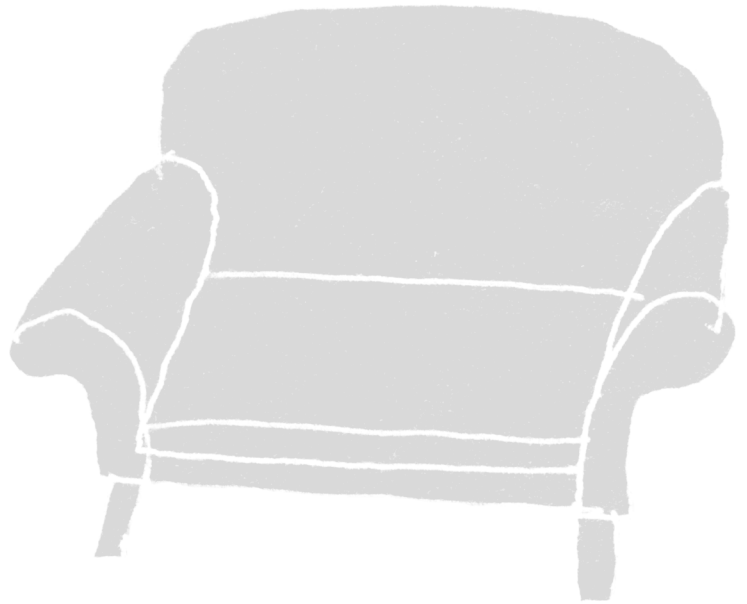
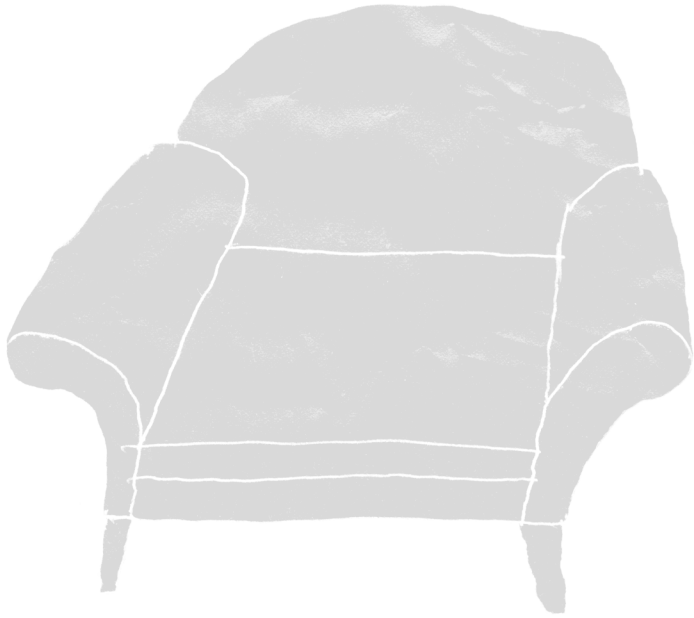

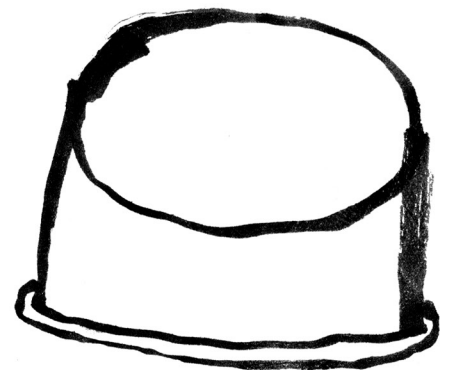
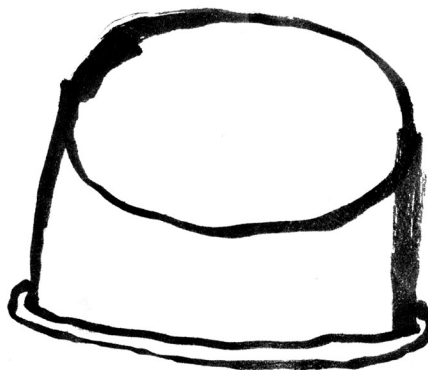
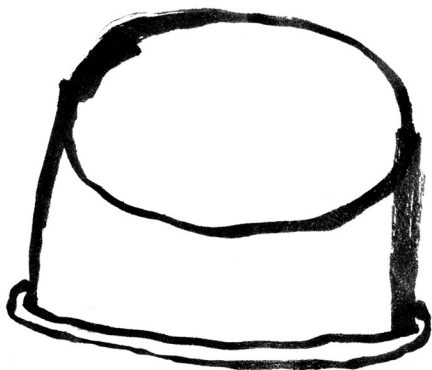
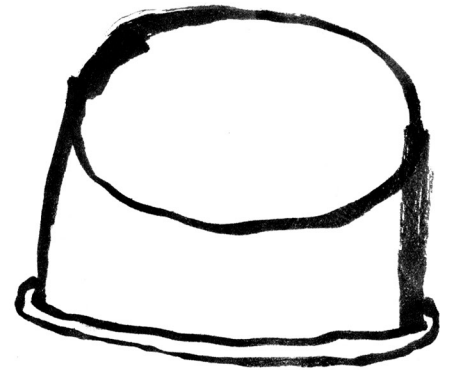
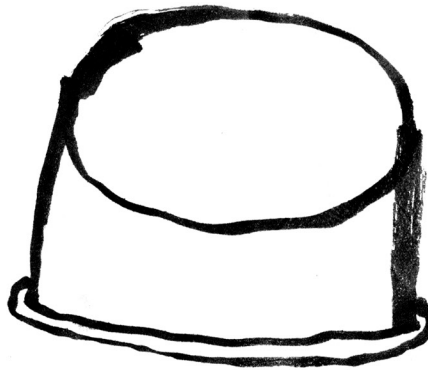
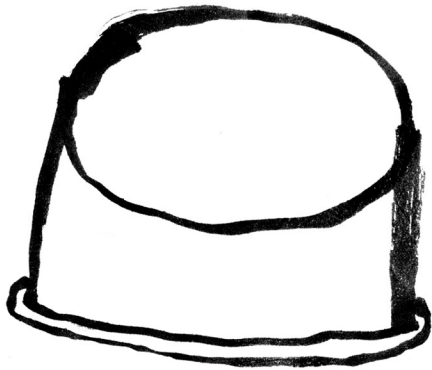
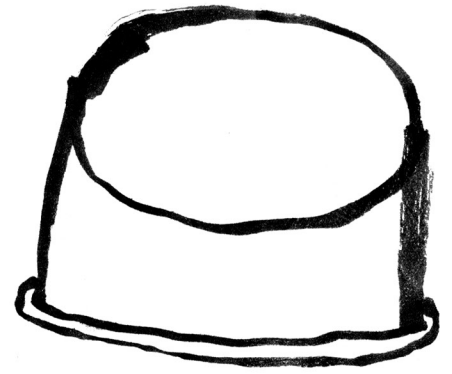
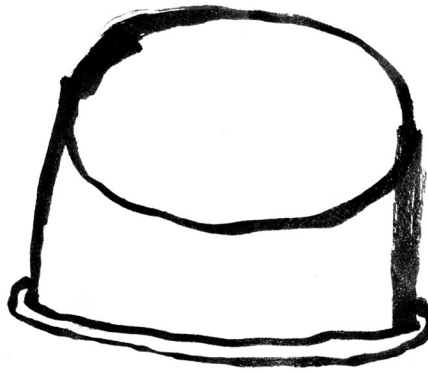

There are lots of things puppies like to eat.

Think of 8 THINGS that a dog might eat, drawing them in the bowls. Then: Think of 8 names for dogs and write them on the food bowls.

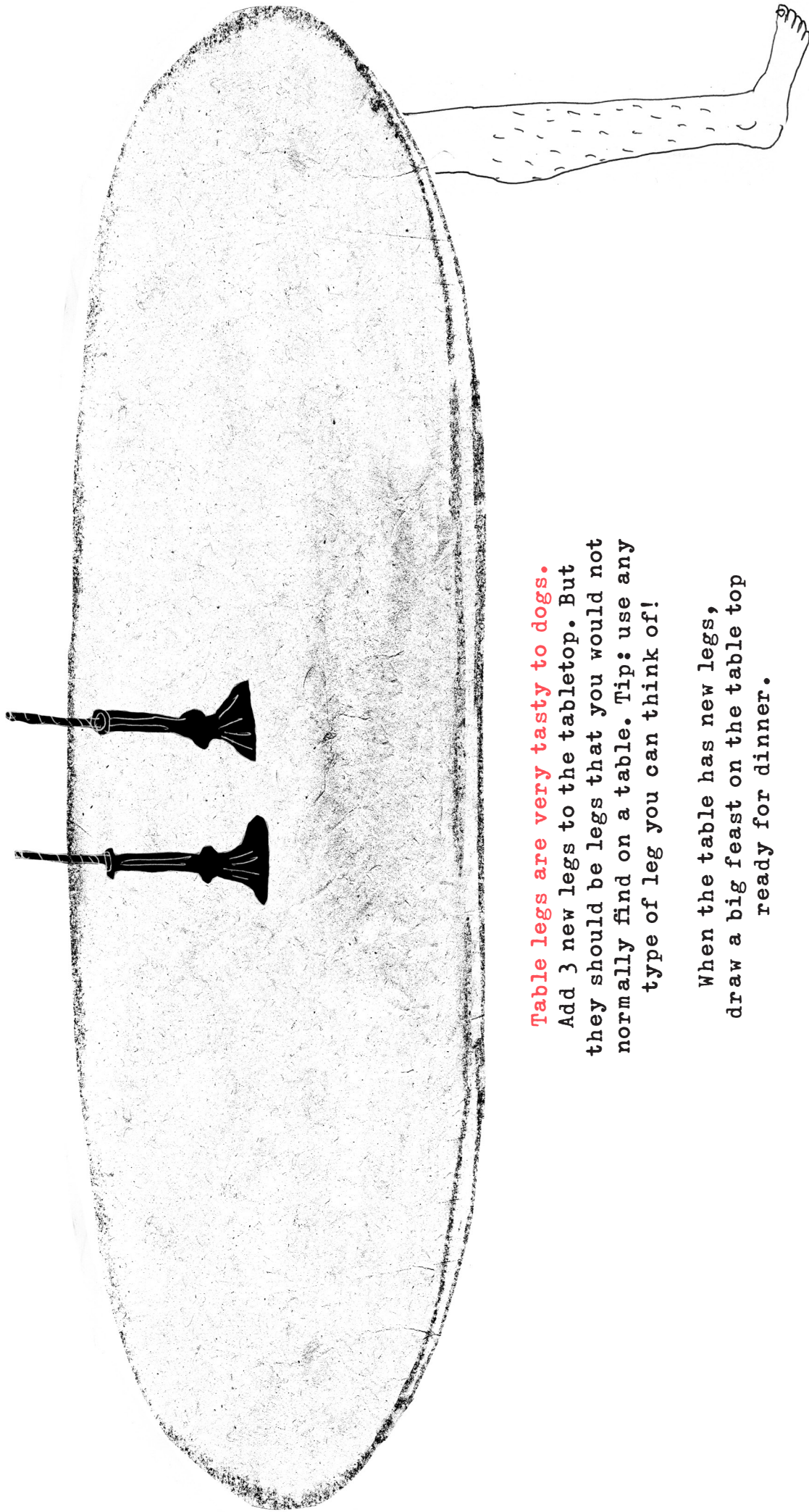

**Table legs are very tasty to dogs.**

Add 3 new legs to the tabletop. But they should be legs that you would not normally find on a table. Tip: use any type of leg you can think of!

When the table has new legs,  
draw a big feast on the table top  
ready for dinner.

Hen's toy is made up of parts from different things.

Design your own dog toy using things that might get thrown away or recycled. Make a drawing of your toy in the space below...

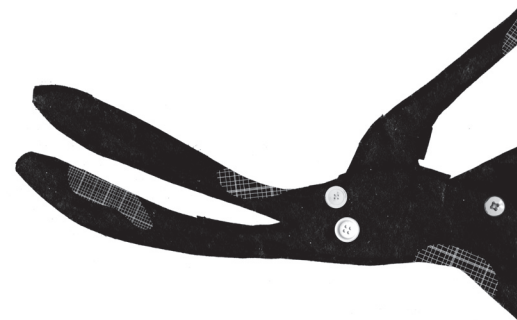

Socks are usually discarded when they get holes in them.  
But they can be mended, if you know how to sew.  
Think of 5 uses for an old sock that can't be mended:

- 1. \_\_\_\_\_
- 2. \_\_\_\_\_
- 3. \_\_\_\_\_
- 4. \_\_\_\_\_
- 5. \_\_\_\_\_



Grandma makes a lot of her own clothes, and fixes anything that needs fixing. Name 3 things you could get fixed and continue using instead of throwing out and replacing with something new?

- 1. \_\_\_\_\_
- 2. \_\_\_\_\_
- 3. \_\_\_\_\_

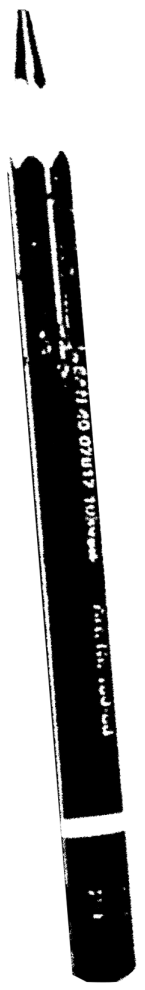

The boy brought Hen home from the animal shelter  
in a cardboard box that used to be for cereal.

A cardboard box can be very useful once it's  
original use is complete. Show this box being used  
for something it wasn't intended for...

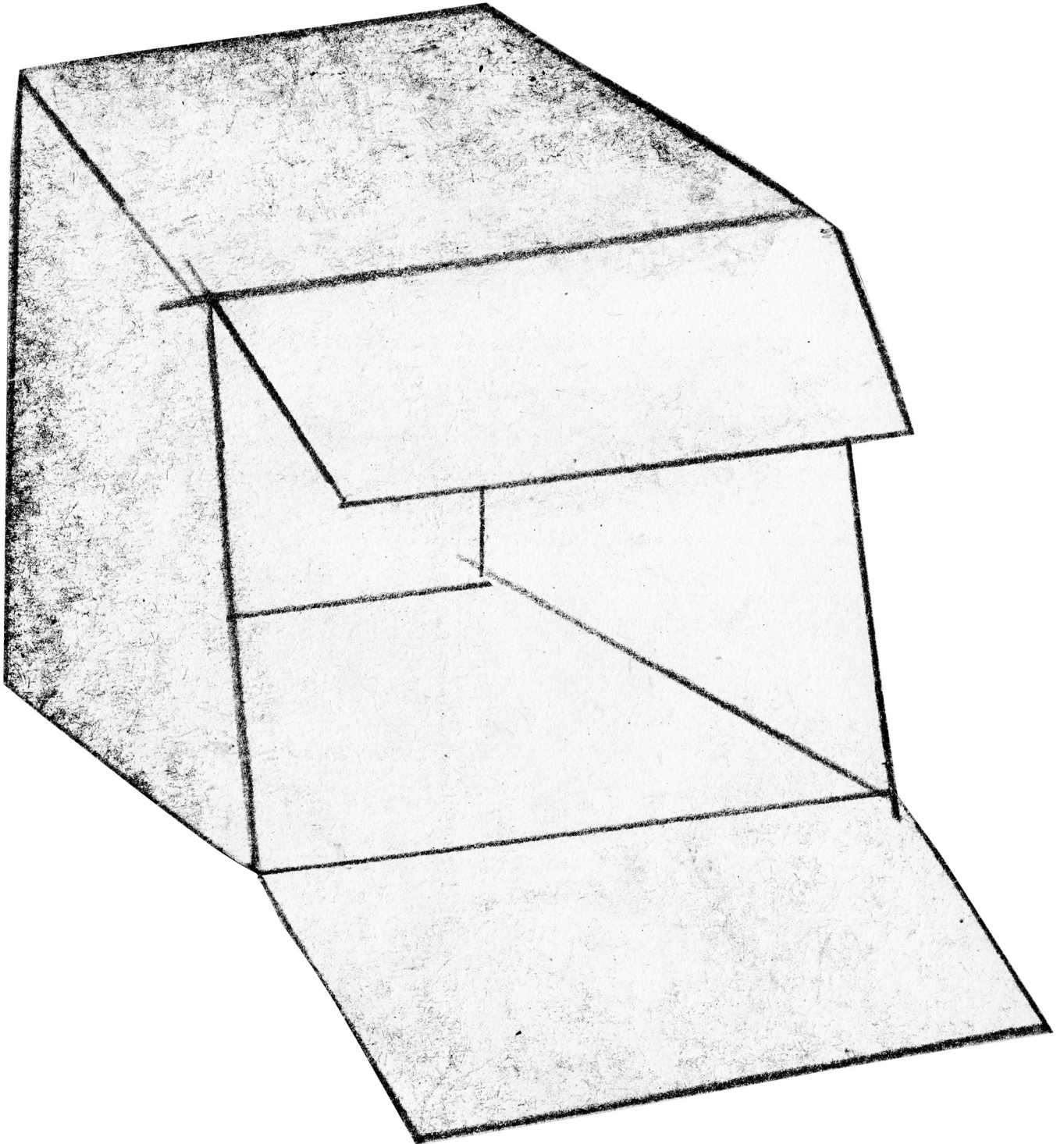

The boy had to get used to Hen pulling on his lead. I didn't draw Hen in my picture of the dog walk — I just drew the family reacting to Hen. Add Hen to the end of the lead below. You can draw him, or draw him on another piece of paper and paste him on to this paper. Try anything you like.

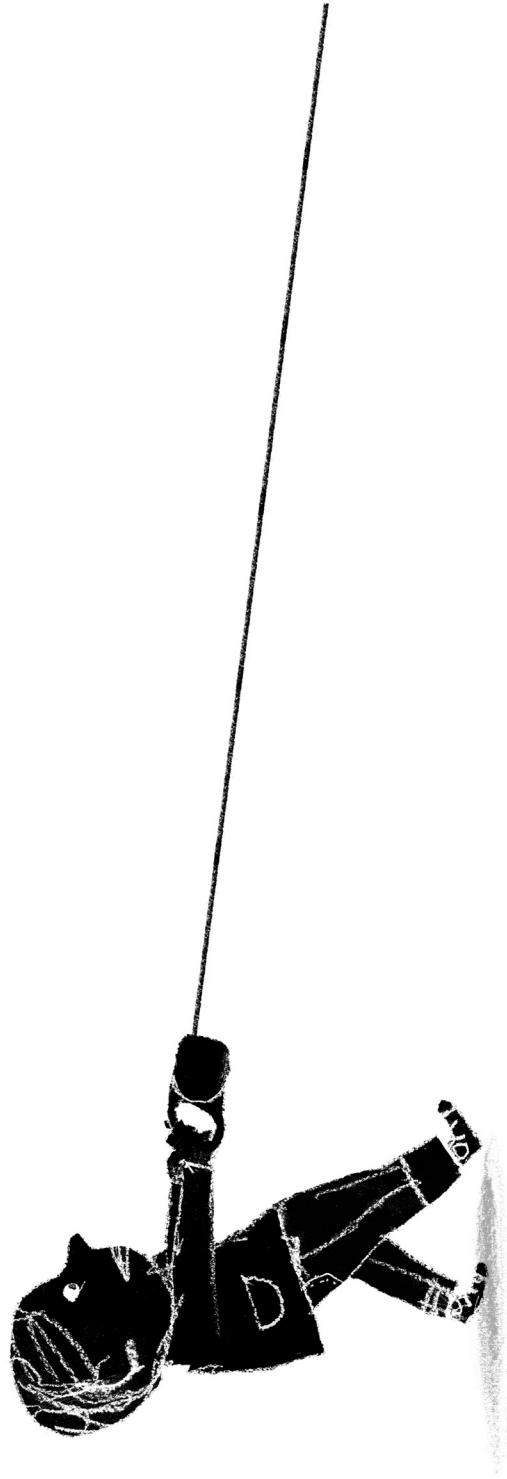

Just because you can mend your socks doesn't mean they don't go missing like regular socks. Draw a line from a sock in the top group to its matching sock in the lower group. If you can link all seven in under 15 seconds, you're very observant.

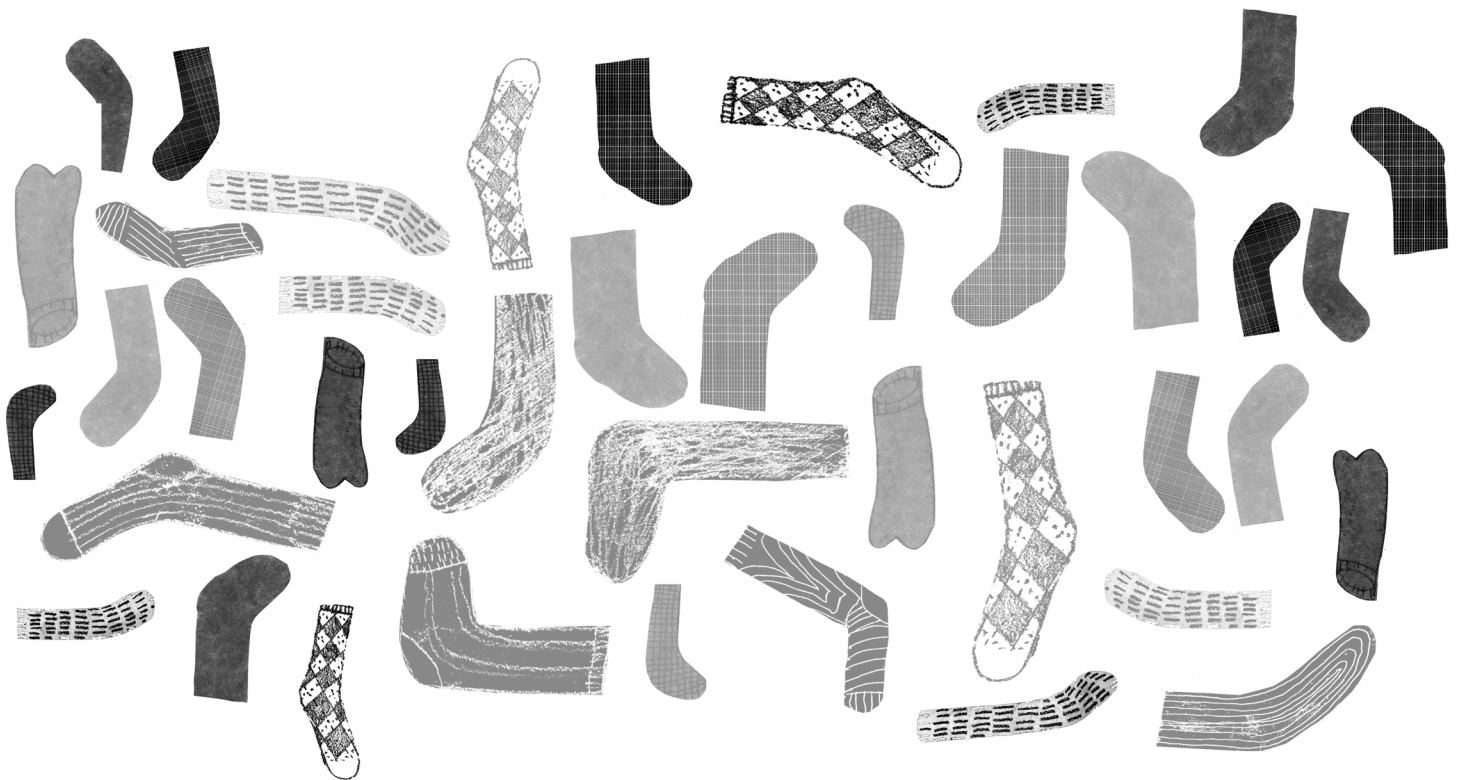

You're the illustrator, designer and author of your own book. Think of a title and illustration for the cover of your book. What best represents the idea of your story? What should the title look like? What font could you use? What colour should it be?



Tip 1: Plan the design on a separate piece of paper before you draw on this cover.  
Tip 2: Don't forget to put your name somewhere on the front cover!

**Make your own book...** Got your own story to tell? Make a book with pages that open nicely. This shows how to make a 12 page book, but use as many pages as you need. The trick is to fold the paper sharply so the sheets nest together well. Using cotton thread to sew the nested pages together is the secret to the pages opening and turning like a real book. (You can staple the pages at the spine, but it doesn't work as well).

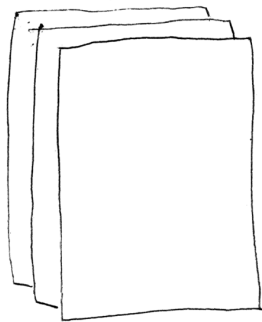

Take three A4 sheets (makes 12 pages).

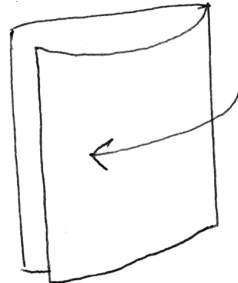

Fold each page in half.

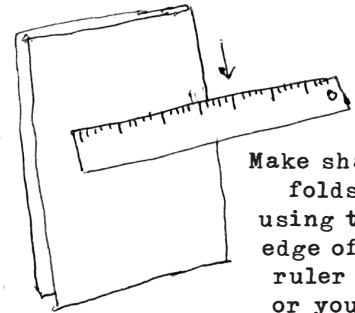

Make sharp folds using the edge of a ruler — or your thumbnail.

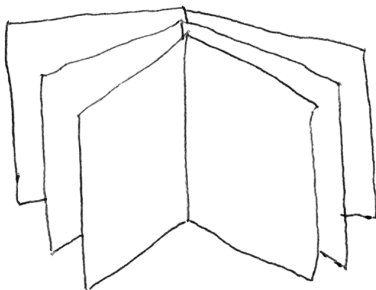

Nest the folded pages together.

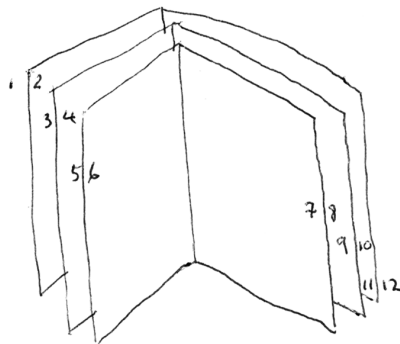

(Each leaf is 2 pages: always multiples of 4 pages when you add a folded A4.)

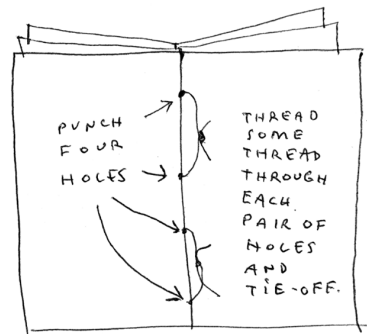

Use a needle to punch 4 holes straight through the folds of all 3 sheets. Sew the pages together and tie-off.

**Now you have a blank, twelve page book you can add your illustrations and text (words) to.** Draw straight onto the book, or cut and paste drawings from other pieces of paper (hint: you may even print out your story on the computer and cut and paste the words into your book).

**Level-up to the deluxe version...**

Add a hard cover and a jacket with flaps: Take a piece of A4 card and fold it like you did the pages. Sew the cover and pages together in one go (or you can add a cover even if you've sewn the pages). For the jacket, take a piece of paper longer than A4 (A3 is good) and fold around your hard cover. Trim it down to the correct height. The jacket is not attached and is held on by the flaps, like a real book dust jacket.

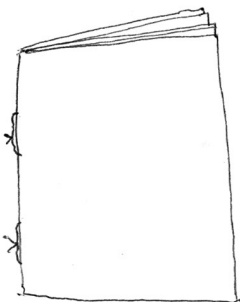

1. Take your nested pages (or use the already-sewn pages)

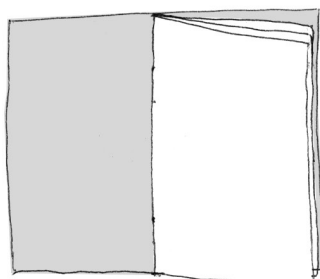

2. Add folded card and sew both parts together at the spine.

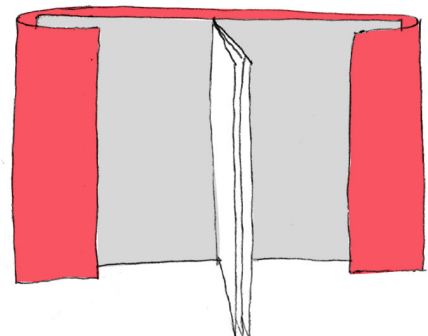

3. Fold a jacket around your hard cover book, letting the flaps keep it in place.